

# Wardrobe bench seating system Type U



**The wardrobe bench seating system with hpl bench seat tops and aluminium supporting stand with numerous features:**

- Universally applicable in all wet and dry areas
- HPL bench seat top:  
resistant to water, scratches, impact and chemicals
- Supports and peg rails made of corrosion  
resistant aluminium tubes
- Consulting services, planning aids and design  
solutions to satisfy any requirement
- Custom built
- Continuous colour options to harmonise  
with other KEMMLIT products

## The quality

Type U wardrobe bench seating with peg rails, quality without compromises. The bench seat tops made of solid grade HPL panels with additional overlay, combined with the supports and peg rails, made of either satin anodised or powder-coated aluminium tubes, create a robust and extremely resilient bench seat. Rounded corners and edges minimise risk of injury and ease cleaning. Resistant to water, mechanical damage and vandalism and also easy to clean – qualities which promise longevity.



U1 model 3000 and model 3800



U1 model 3100



U1 model 5110 including shoe rack



U1 model 5210 including shoe rack



U1 model 3600



U1 modell 3000 with peg rail/hooks



U1 modell 3000

## Design and Colours

Experience design and stability. Visualise creativity. That is KEMMLIT type U. The various bench seat models with the matching safety peg rails can be individually designed. As a means of design many colours according to the colour chart can be applied.



### Safety peg rail no. 1010

Made of satin anodised aluminium tube profiles  $\varnothing$  40 mm, end part matt chromed. Instead of satin anodised, the profiles can be powder-coated in various colours according to the KEMMLIT colour chart.

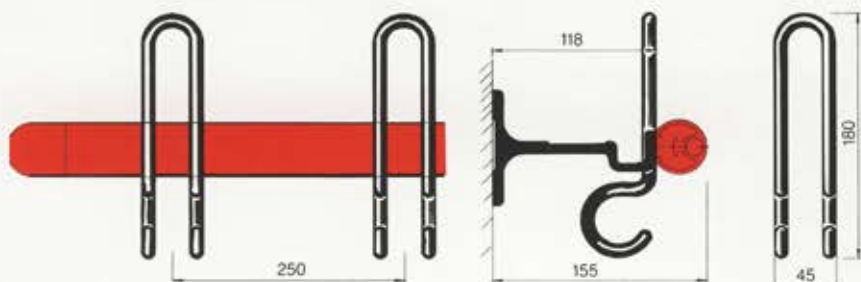

### Safety hooks three-in-one no. 1015

Made of satin anodised aluminium.



U1 as attached bench seating



U1 standard corner detail



U1 optional finish

This substantial bench seating range type U comes in many variations, with matching safety peg rails, is not only suitable for swimming pools, sports facilities and schools, but also for staff and cloak rooms in industrial or administrative buildings.



U1

### Solid grade laminate seat top U1

282 mm wide, 26 mm thick, rounded, radius 13 mm, up to 2000 mm possible without joints.



U2

### Solid grade laminate seat top U2

Three slats, each 90 mm wide, 26 mm thick, rounded, up to 2000 mm possible without joints.

## Bench seating options

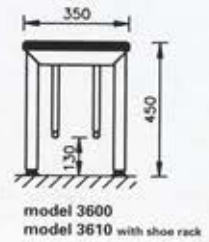
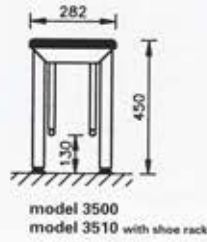
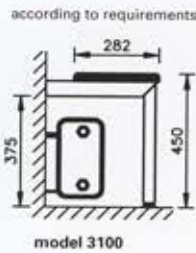
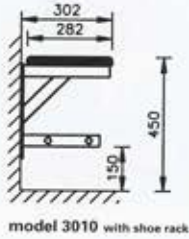
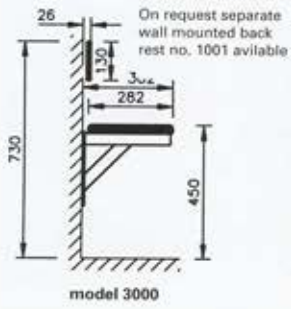

### Supports and peg rails:

Framework made of aluminium tubes  $\varnothing$  38,5 mm, 3,2 mm thick. The supporting leg ends are provided with adjustable plastic plug-in caps to compensate tolerances at site and are provided for floor mounting.

### Bench seat tops:

26 mm thick solid grade HPL-panels, 280 (350) mm wide, doubled up around the edges and rounded, radius 13 mm. Up to 2000 mm length no joints necessary. Corners are shapely rounded, radius 33 mm.

Model 5100 and 5110 must be attached to a wall.

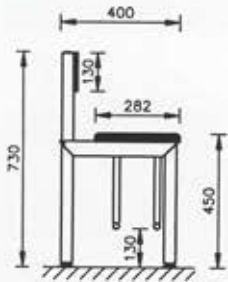

Model 3700  
Model 3710 with shoe rack

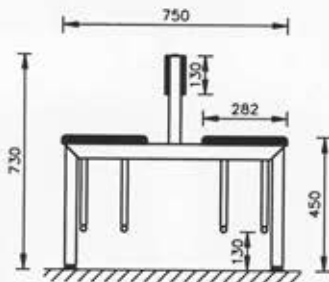

Model 3800  
Model 3810 with shoe rack

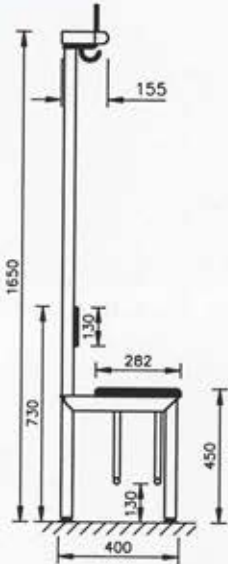

Model 5100  
Model 5110 with shoe rack

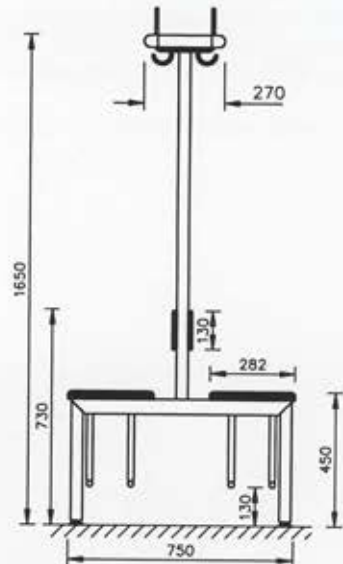

Model 5200  
Model 5210 with shoe rack

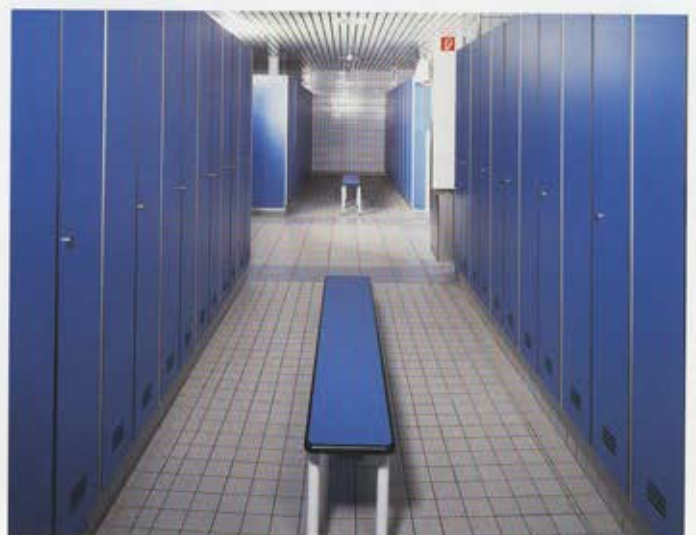

Subject to technical changes 09/06

KEMMLIT UK

Bays Platt, Skirmett, Henley-on-Thames,  
Oxfordshire RG9 6TD United Kingdom  
Tel: +44(0)1491 638606 Fax: +44(0)1491 638072  
www.kemmlituk.com info@kemmlituk.com

